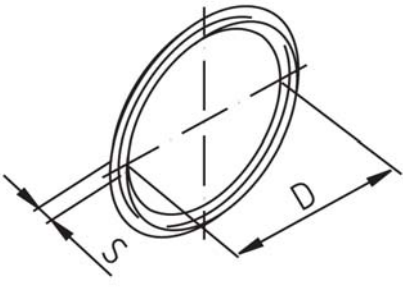

NW	D1	D2	D3	L	E	
						Union DIN 11864/1 11866 A
						<i>Koppeling DIN 11864/1 11866 A</i>
10	10	13	38	76	Rd 28 x 1/8"	
15	16	19	44	76	Rd 34 x 1/8"	
20	20	23	54	76	Rd 44 x 1/6"	
25	26	29	63	77	Rd 52 x 1/6"	
32	32	35	70	88	Rd 58 x 1/6"	
40	38	41	78	88	Rd 65 x 1/6"	
50	50	53	92	89	Rd 78 x 1/6"	
65	66	70	112	113	Rd 95 x 1/6"	
80	81	85	127	117	Rd 110 x 1/4"	
100	100	104	148	120	Rd 130 x 1/4"	

NW	D1	D2	L	L1	E	
						Male DIN 11864/1 11866 A
						<i>Draadstuk DIN 11864/1 11866 A</i>
10	10	13	41	27	Rd 28 x 1/8"	
15	16	19	41	27	Rd 34 x 1/8"	
20	20	23	43	26	Rd 44 x 1/6"	
25	26	29	43	26	Rd 52 x 1/6"	
32	32	35	48	32	Rd 58 x 1/6"	
40	38	41	48	31	Rd 65 x 1/6"	
50	50	53	48	30	Rd 78 x 1/6"	
65	66	70	60	40	Rd 95 x 1/6"	
80	81	85	64	40	Rd 110 x 1/4"	
100	100	104	64	40	Rd 130 x 1/4"	

NW	D1	D2	D3	L	L1	
						Liner DIN 11864/1 11866 A
						<i>Puntstuk DIN 11864/1 11866 A</i>
10	10	13	21,9	39	27	
15	16	19	27,9	39	27	
20	20	23	35,9	38	26	
25	26	29	42,9	40	26	
32	32	35	48,9	47	32	
40	38	41	54,9	47	31	
50	50	53	66,9	48	30	
65	66	70	84,9	61	40	
80	81	85	98,9	61	40	
100	100	104	118,9	66	40	

NW	D1	D2	L	L1	E	
						Nut DIN 11851
						<i>Wartelmoer DIN 11851</i>
10	38	19	18	15	Rd 28 x 1/8"	
15	44	25	18	15	Rd 34 x 1/8"	
20	54	31	20	17	Rd 44 x 1/6"	
25	63	36	21	18	Rd 52 x 1/6"	
32	70	42	21	18	Rd 58 x 1/6"	
40	78	49	21	18	Rd 65 x 1/6"	
50	92	62	22	19	Rd 78 x 1/6"	
65	112	80	25	21	Rd 95 x 1/6"	
80	127	94	29	25	Rd 110 x 1/4"	
100	148	115	31	26	Rd 130 x 1/4"	

<i>O-ring DIN 11864/1 11866 A</i>	NW	D	S
<i>O-ring DIN 11864/1 11866 A</i>			
	10	12	3,5
	15	18	3,5
	20	22	3,5
	25	28	3,5
	32	34	5
	40	40	5
	50	52	5
	65	68	5
	80	83	5
	100	102	5
	125	127	5
	150	152	5

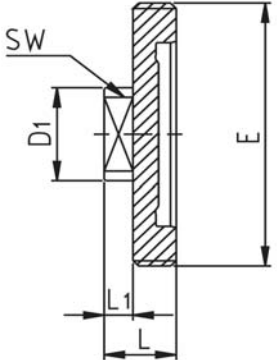
<i>Male blank DIN 11864/1 11866 A</i>	NW	D1	SW	L	L1	E
<i>Blinddraadstuk DIN 11864/1 11866 A</i>						
	10	22	19	22	10	Rd 28 x 1/8"
	15	25	22	22	10	Rd 34 x 1/8"
	20	25	22	24	10	Rd 44 x 1/6"
	25	34	27	24	10	Rd 52 x 1/6"
	32	34	27	24	10	Rd 58 x 1/6"
	40	34	27	24	10	Rd 65 x 1/6"
	50	34	27	24	10	Rd 78 x 1/6"
	65	34	27	26	10	Rd 95 x 1/6"
	80	34	27	30	10	Rd 110 x 1/4"
	100	34	27	30	10	Rd 130 x 1/4"

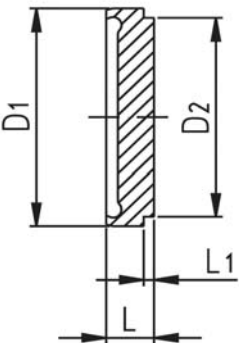
<i>Liner blank DIN 11864/1 11866 A</i>	NW	D1	D2	L	L1
<i>Blindpuntstuk DIN 11864/1 11866 A</i>					
	10	21,9	18	9	3
	15	27,9	24	9	3
	20	35,9	30	10	3
	25	42,9	35	12	3
	32	48,9	41	13	3
	40	54,9	48	13	3
	50	66,9	61	14	3
	65	84,9	79	16	4
	80	98,9	93	16	4
	100	118,9	114	20	5

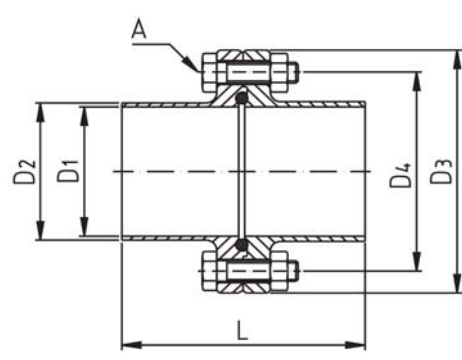
NW	D1	D2	D3	D4	L	A	Flange connection DIN 11864/2 11866 A Flensverbinding DIN 11864/2 11866 A
10	10	13	54	37	80	4/M8 x 30	
15	16	19	59	42	80	4/M8 x 30	
20	20	23	64	47	80	4/M8 x 30	
25	26	29	70	53	80	4/M8 x 30	
32	32	35	76	59	90	4/M8 x 30	
40	38	41	82	65	90	4/M8 x 30	
50	50	53	94	77	90	4/M8 x 30	
65	66	70	113	95	108	8/M8 x 30	
80	81	85	133	112	116	8/M10 x 35	
100	100	104	159	137	116	8/M10 x 40	
125	125	129	183	161	120	8/M10 x 40	
150	150	154	213	188	120	8/M12 x 50	

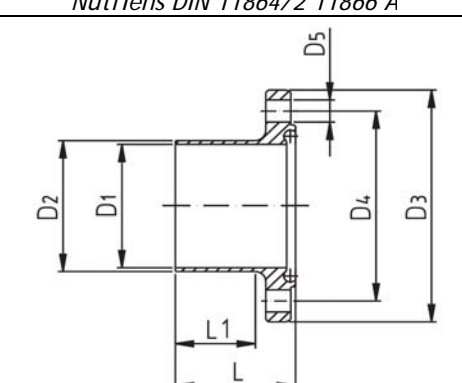
NW	D1	D2	D3	D4	L	L1	Nut flange DIN 11864/2 11866 A Nutflens DIN 11864/2 11866 A
10	10	13	54	37	41,5	26	
15	16	19	59	42	41,5	26	
20	20	23	64	47	41,5	26	
25	26	29	70	53	41,5	26	
32	32	35	76	59	46,5	31	
40	38	41	82	65	46,5	31	
50	50	53	94	77	46,5	31	
65	66	70	113	95	55,5	40	
80	81	85	133	112	59,5	42	
100	100	104	159	137	59,5	40	
125	125	129	183	161	61,5	42	
150	150	154	213	188	61,5	40	

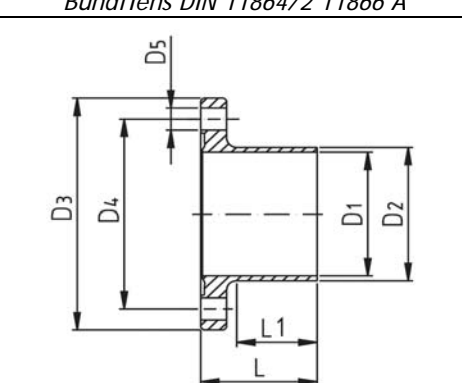
NW	D1	D2	D3	D4	L	L1	Liner flange DIN 11864/2 11866 A Bundflens DIN 11864/2 11866 A
10	10	13	54	37	40	26	
15	16	19	59	42	40	26	
20	20	23	64	47	40	26	
25	26	29	70	53	40	26	
32	32	35	76	59	45	31	
40	38	41	82	65	45	31	
50	50	53	94	77	45	31	
65	66	70	113	95	54	40	
80	81	85	133	112	58	42	
100	100	104	159	137	58	40	
125	125	129	183	161	60	42	
150	150	154	213	188	60	40	

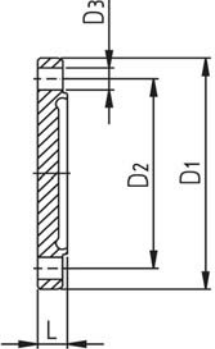
<i>Blank nut flange DIN 11864/2 11866 A</i> <i>Blindnutflens DIN 11864/2 11866 A</i>	NW	D1	D2	D3	L
	10	54	37	4x ø 9	11,5
	15	59	42	4x ø 9	11,5
	20	64	47	4x ø 9	11,5
	25	70	53	4x ø 9	11,5
	32	76	59	4x ø 9	11,5
	40	82	65	4x ø 9	11,5
	50	94	77	4x ø 9	11,5
	65	113	95	8x ø 9	11,5
	80	133	112	8x ø 11	13,5
	100	159	137	8x ø 11	15,5
	125	183	161	8x ø 11	15,5
	150	213	188	8x ø 14	17,5

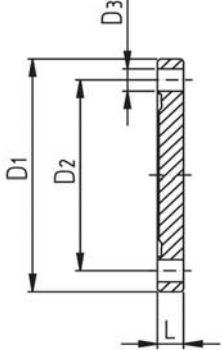
<i>Blank liner flange DIN 11864/2 11866 A</i> <i>Blindbundflens DIN 11864/2 11866 A</i>	NW	D1	D2	D3	L
	10	54	37	4x ø 9	10
	15	59	42	4x ø 9	10
	20	64	47	4x ø 9	10
	25	70	53	4x ø 9	10
	32	76	59	4x ø 9	10
	40	82	65	4x ø 9	10
	50	94	77	4x ø 9	10
	65	113	95	8x ø 9	10
	80	133	112	8x ø 11	12
	100	159	137	8x ø 11	14
	125	183	161	8x ø 11	14
	150	213	188	8x ø 14	16

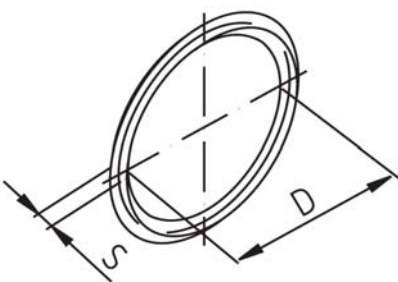
<i>O-ring DIN 11864/1 11866 A</i> <i>O-ring DIN 11864/1 11866 A</i>	NW	D	S
	10	12	3,5
	15	18	3,5
	20	22	3,5
	25	28	3,5
	32	34	5
	40	40	5
	50	52	5
	65	68	5
	80	83	5
	100	102	5
	125	127	5
150	152	5	

NW	D1	D2	D3	A	L
10	10	13	34	45	76
15	16	19	34	45	76
20	20	23	50,5	64	76
25	26	29	50,5	64	77
32	32	35	50,5	64	88
40	38	41	64	77	88
50	50	53	77,5	91	89
65	66	70	91	104	113
80	81	85	106	119	117
100	100	104	130	143	120

Clamp connection DIN 11864/3 11866 A
Klemverbinding DIN 11864/3 11866 A

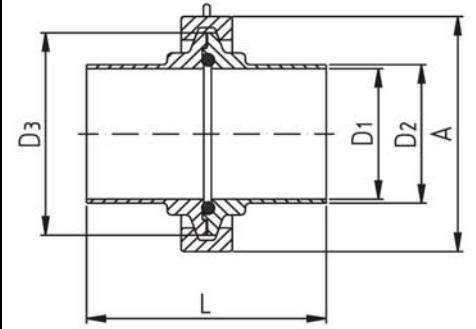

NW	D1	D2	D3	L	L1
10	10	13	34	38	26
15	16	19	34	38	26
20	20	23	50,5	38	26
25	26	29	50,5	38,5	28
32	32	35	50,5	44	30
40	38	41	64	44	30
50	50	53	77,5	44,5	30
65	66	70	91	56,5	40
80	81	85	106	58,5	40
100	100	104	130	60	40

Clamp liner DIN 11864/3 11866 A
Bundferrule DIN 11864/3 11866 A

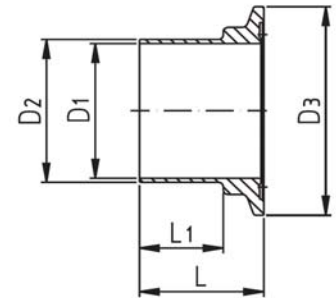

NW	D1	D2	D3	L	L1
10	10	13	34	39,5	26
15	16	19	34	39,5	26
20	20	23	50,5	39,5	24
25	26	29	50,5	40	28
32	32	35	50,5	45,5	30
40	38	41	64	45,5	30
50	50	53	77,5	46	30
65	66	70	91	58	40
80	81	85	106	60	40
100	100	104	130	61,5	40

Clamp Nut DIN 11864/3 11866 A
Nutferrule DIN 11864/3 11866 A

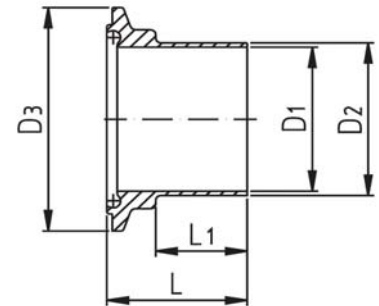

NW	A	B	D1
10	45	63	34
15	45	63	34
20	64	88	50,5
25	64	88	50,5
32	64	88	50,5
40	77	105	64
50	91	123	77,5
65	104	137	91
80	119	155	106
100	143	168	130

Heavy duty clamp
Clampbeugel 2 delig zwaar

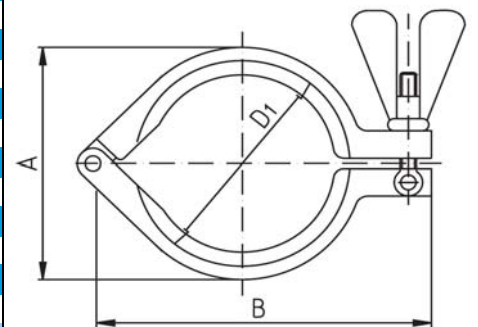

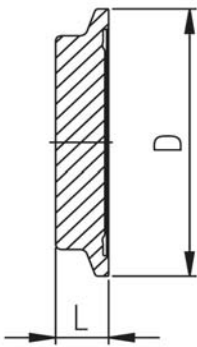
<i>Blind cap DIN 11864/3 11866 A</i> <i>Blindbunferule DIN 11864/3 11866 A</i>	NW	D	L
	10	34	8
	15	34	8
	20	50,5	8
	25	50,5	8
	32	50,5	8
	40	64	8
	50	77,5	8
	65	91	8
	80	106	8
	100	130	8

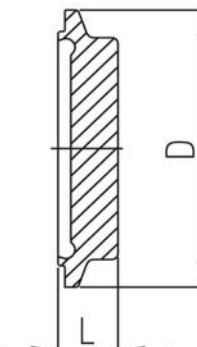
<i>Blind clamp DIN 11864/3 11866 A</i> <i>Blindnutferrule DIN 11864/3 11866 A</i>	NW	D	L
	10	34	10
	15	34	10
	20	50,5	10
	25	50,5	10
	32	50,5	10
	40	64	10
	50	77,5	10
	65	91	10
	80	106	10
	100	130	10

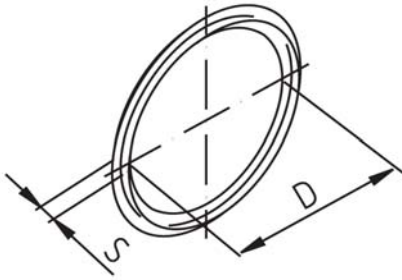
<i>O-ring DIN 11864/1 11866 A</i> <i>O-ring DIN 11864/1 11866 A</i>	NW	D	S
	10	12	3,5
	15	18	3,5
	20	22	3,5
	25	28	3,5
	32	34	5
	40	40	5
	50	52	5
	65	68	5
	80	83	5
	100	102	5
	125	127	5
	150	152	5

NW	D1	D2	D3	L	E	Union DIN 11864/1 11866 C Koppeling DIN 11864/1 11866 C
1/2"	9,4	12,7	38	76	Rd 28 x 1/8"	
3/4"	15,75	19,05	44	76	Rd 34 x 1/8"	
1"	22,1	25,4	63	77	Rd 52 x 1/6"	
1,5"	34,8	38,1	78	88	Rd 65 x 1/6"	
2"	47,5	50,8	92	89	Rd 78 x 1/6"	
2,5"	60,2	63,5	112	115	Rd 95 x 1/6"	
3"	72,9	76,2	127	117	Rd 110 x 1/4"	
4"	97,38	101,6	148	119	Rd 130 x 1/4"	

NW	D1	D2	L	L1	E	Male DIN 11864/1 11866 C Draadstuk DIN 11864/1 11866 C
1/2"	9,4	12,7	41	27	Rd 28 x 1/8"	
3/4"	15,75	19,05	41	27	Rd 34 x 1/8"	
1"	22,1	25,4	43	26	Rd 52 x 1/6"	
1,5"	34,8	38,1	48,5	30	Rd 65 x 1/6"	
2"	47,5	50,8	48,5	30	Rd 78 x 1/6"	
2,5"	60,2	63,5	60	40	Rd 95 x 1/6"	
3"	72,9	76,2	64	40	Rd 110 x 1/4"	
4"	97,38	101,6	64	40	Rd 130 x 1/4"	

NW	D1	D2	D3	L	L1	Liner DIN 11864/1 11866 C Puntstuk DIN 11864/1 11866 C
1/2"	9,4	12,7	21,9	39	27	
3/4"	15,75	19,05	27,9	39	27	
1"	22,1	25,4	42,9	40	26	
1,5"	34,8	38,1	54,9	46,5	30	
2"	47,5	50,8	66,9	47,5	30	
2,5"	60,2	63,5	84,9	63	40	
3"	72,9	76,2	98,9	61	40	
4"	97,38	101,6	118,9	65	40	

NW	D1	D2	L	L1	E	Nut DIN11851 Wartelmoer DIN 11851
1/2"	38	19	18	15	Rd 28 x 1/8"	
3/4"	44	25	18	15	Rd 34 x 1/8"	
1"	63	36	21	18	Rd 52 x 1/6"	
1,5"	78	49	21	18	Rd 65 x 1/6"	
2"	92	62	22	19	Rd 78 x 1/6"	
2,5"	112	80	25	21	Rd 95 x 1/6"	
3"	127	94	29	25	Rd 110 x 1/4"	
4"	148	115	31	26	Rd 130 x 1/4"	

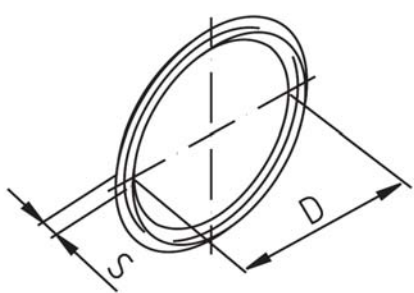
<i>O-ring DIN 11864/1 DIN 11866 C</i>	NW	D	S
<i>O-ring DIN 11864/1 11866 C</i>			
			
1/2"	12	3,5	
3/4"	18	3,5	
1"	24	3,5	
1,5"	37	5	
2"	50	5	
2,5"	62	5	
3"	75	5	
4"	100	5	

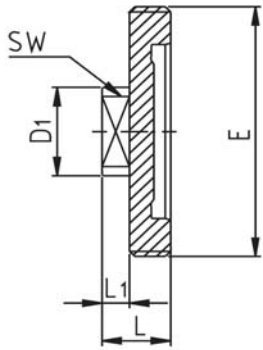
<i>Male blank DIN 11864/1 11866 C</i>	NW	D1	SW	L	L1	E
<i>Blinddraadstuk DIN 11864/1 11866 C</i>						
						
1/2"	34	27	22	10	Rd 28 x 1/8"	
3/4"	34	27	22	10	Rd 34 x 1/8"	
1"	34	27	24	10	Rd 52 x 1/6"	
1,5"	34	27	24	10	Rd 65 x 1/6"	
2"	34	27	24	10	Rd 78 x 1/6"	
2,5"	34	27	26	10	Rd 95 x 1/6"	
3"	34	27	30	10	Rd 110 x 1/4"	
4"	34	27	30	10	Rd 130 x 1/4"	

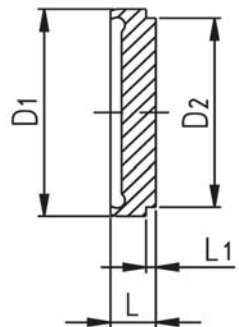
<i>Liner blank DIN 11864/1 11866 C</i>	NW	D1	D2	L	L1
<i>Blindpuntstuk DIN 11864/1 11866 C</i>					
					
1/2"	21,9	18	9	3	
3/4"	27,9	24	9	3	
1"	42,9	35	12	3	
1,5"	54,9	48	13	3	
2"	66,9	61	14	3	
2,5"	84,9	79	16	4	
3"	98,9	93	16	4	
4"	118,9	114	20	5	

NW	D1	D2	D3	D4	L	A	Flange connection DIN 11864/2 11866 C Flensverbinding DIN 11864/2 11866 C
1/2"	9,4	12,7	54	37	80	4/M8 x 30	
3/4"	15,75	19,05	59	42	80	4/M8 x 30	
1"	22,1	25,4	66	49	80	4/M8 x 30	
1,5"	34,8	38,1	79	62	90	4/M8 x 30	
2"	47,5	50,8	92	75	90	4/M8 x 30	
2,5"	60,2	63,5	107	89	108	8/M8 x 30	
3"	72,9	76,2	125	104	112	8/M10 x 30	
4"	97,38	101,6	157	135	116	8/M10 x 35	

NW	D1	D2	D3	D4	L	L1	Nut flange 11864/2 11866 C Nutflens DIN 11864/2 11866 C
1/2"	9,4	12,7	54	37	41,5	26	
3/4"	15,75	19,05	59	42	41,5	26	
1"	22,1	25,4	66	49	41,5	26	
1,5"	34,8	38,1	79	62	46,5	31	
2"	47,5	50,8	92	75	46,5	31	
2,5"	60,2	63,5	107	89	55,5	40	
3"	72,9	76,2	125	104	57,5	40	
4"	97,38	101,6	157	135	59,5	40	

NW	D1	D2	D3	D4	L	L1	Liner flange 11864/2 11866 C Bundflens DIN 11864/2 11866 C
1/2"	9,4	12,7	54	37	40	26	
3/4"	15,75	19,05	59	42	40	26	
1"	22,1	25,4	66	49	40	26	
1,5"	34,8	38,1	79	62	45	31	
2"	47,5	50,8	92	75	45	31	
2,5"	60,2	63,5	107	89	54	40	
3"	72,9	76,2	125	104	56	40	
4"	97,38	101,6	157	135	58	40	

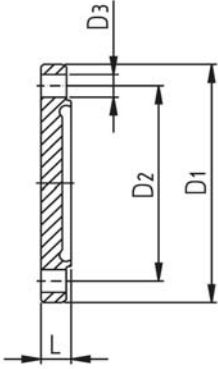
<i>Blank nut flange DIN 11864/2 11866 C</i> <i>Blindnutflens DIN 11864/2 11866 C</i>	NW	D1	D2	D3	L
	1/2"	54	37	4x ø 9	11,5
	3/4"	59	42	4x ø 9	11,5
	1"	66	49	4x ø 9	11,5
	1,5"	79	62	4x ø 9	11,5
	2"	92	75	4x ø 9	11,5
	2,5"	107	89	8x ø 9	11,5
	3"	125	104	8x ø 11	13,5
	4"	157	135	8x ø 11	15,5

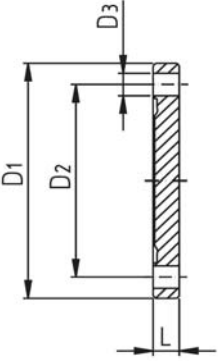
<i>Blank liner flange DIN 11864/2 11866 C</i> <i>Blindbundflens DIN 11864/2 11866 C</i>	NW	D1	D2	D3	L
	1/2"	54	37	4x ø 9	10
	3/4"	59	42	4x ø 9	10
	1"	66	49	4x ø 9	10
	1,5"	79	62	4x ø 9	10
	2"	92	75	4x ø 9	10
	2,5"	107	89	8x ø 9	10
	3"	125	104	8x ø 11	12
	4"	157	135	8x ø 11	14

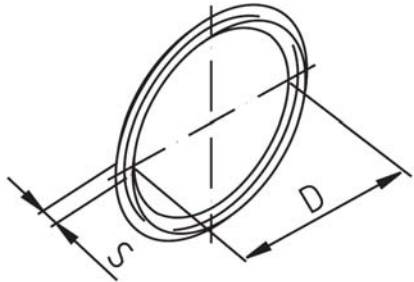
<i>O-ring DIN 11864/1 DIN 11866 C</i> <i>O-ring DIN 11864/1 11866 C</i>	NW	D	S
	1/2"	12	3,5
	3/4"	18	3,5
	1"	24	3,5
	1,5"	37	5
	2"	50	5
	2,5"	62	5
	3"	75	5
	4"	100	5

NW	D1	D2	D3	A	L
1/2"	9,4	12,7	34	45	76
3/4"	15,75	19,05	34	45	76
1"	22,1	25,4	50,5	64	76
1,5"	34,8	38,1	64	77	77
2"	47,5	50,8	77,5	91	88
2,5"	60,2	63,5	91	104	88
3"	72,9	76,2	106	119	89
4"	97,38	101,6	130	143	113

Clamp connection DIN 11864/3 11866 C
Klemverbinding DIN 11864/3 11866 C

NW	D1	D2	D3	L	L1
1/2"	9,4	12,7	34	38	26
3/4"	15,75	19,05	34	38	26
1"	22,1	25,4	50,5	38,5	28
1,5"	34,8	38,1	64	44	30
2"	47,5	50,8	77,5	44,5	30
2,5"	60,2	63,5	91	57,5	40
3"	72,9	76,2	106	58,5	40
4"	97,38	101,6	130	59,5	40

Clamp liner DIN 11864/3 11866 C
Bundferrule DIN 11864/3 11866 C

NW	D1	D2	D3	L	L1
1/2"	9,4	12,7	34	39,5	26
3/4"	15,75	19,05	34	39,5	26
1"	22,1	25,4	50,5	40	28
1,5"	34,8	38,1	64	45,5	30
2"	47,5	50,8	77,5	46	30
2,5"	60,2	63,5	91	59	40
3"	72,9	76,2	106	60	40
4"	97,38	101,6	130	61	40

Clamp Nut DIN 11864/3 11866 C
Nutferrule DIN 11864/3 11866 C

NW	A	B	D1
1/2"	45	63	34
3/4"	45	63	34
1"	64	88	50,5
1,5"	77	105	64
2"	91	123	77,5
2,5"	104	137	91
3"	119	155	106
4"	143	178	130

Heavy duty clamp
Clampbeugel 2 delig zwaar

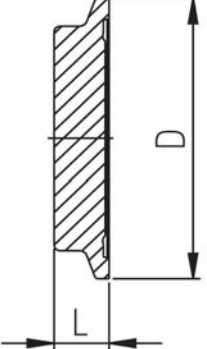
<i>Blind cap DIN 11864/3 11866 C</i> <i>Blindbunderule DIN 11864/3 11866 C</i>	NW	D	L
	1/2"	34	8
	3/4"	34	8
	1"	50,5	8
	1,5"	64	8
	2"	77,5	8
	2,5"	91	8
	3"	106	8
	4"	130	8

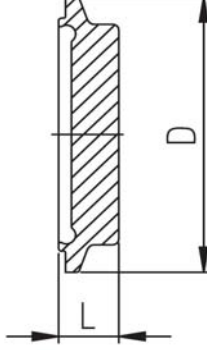
<i>Blind clamp DIN 11864/3 11866 C</i> <i>Blindnutferrule Din 11864/3 11866 C</i>	NW	D	L
	1/2"	34	10
	3/4"	34	10
	1"	50,5	10
	1,5"	64	10
	2"	77,5	10
	2,5"	91	10
	3"	106	10
	4"	130	10

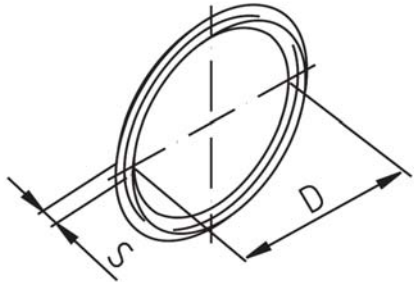
<i>O-ring DIN 11864/1 DIN 11866 C</i> <i>O-ring DIN 11864/1 11866 C</i>	NW	D	S
	1/2"	12	3,5
	3/4"	18	3,5
	1"	24	3,5
	1,5"	37	5
	2"	50	5
	2,5"	62	5
	3"	75	5
	4"	100	5

NW	D1	D2	D3	L	E	
						Union DIN 11864/1 11866 E
						<i>Koppeling DIN 11864/1 11866 B</i>
8	10,3	13,5	38	76	Rd 28 x 1/8"	
10	14,0	17,2	44	76	Rd 34 x 1/8"	
15	18,1	21,3	54	78	Rd 44 x 1/6"	
20	23,7	26,9	63	78	Rd 52 x 1/6"	
25	29,7	33,7	70	88	Rd 58 x 1/6"	
32	38,4	42,4	78	88	Rd 65 x 1/6"	
40	44,3	48,3	92	90	Rd 78 x 1/6"	
50	56,3	60,3	112	114	Rd 95 x 1/6"	
65	72,1	76,1	127	117	Rd 110 x 1/4"	
80	84,3	88,9	148	122	Rd 130 x 1/4"	

NW	D1	D2	L	L1	E	
						Male DIN 11864/1 11866 E
						<i>Draadstuk DIN 11864/1 11866 B</i>
8	10,3	13,5	41	27	Rd 28 x 1/8"	
10	14,0	17,2	41	27	Rd 34 x 1/8"	
15	18,1	21,3	43	27	Rd 44 x 1/6"	
20	23,7	26,9	43	27	Rd 52 x 1/6"	
25	29,7	33,7	48	32	Rd 58 x 1/6"	
32	38,4	42,4	48	32	Rd 65 x 1/6"	
40	44,3	48,3	49	31	Rd 78 x 1/6"	
50	56,3	60,3	60	40	Rd 95 x 1/6"	
65	72,1	76,1	64	40	Rd 110 x 1/4"	
80	84,3	88,9	64	40	Rd 130 x 1/4"	

NW	D1	D2	D3	L	L1	
						Liner DIN 11864/1 11866 E
						<i>Puntstuk DIN 11864/1 11866 B</i>
8	10,3	13,5	21,9	39	27	
10	14,0	17,2	27,9	39	27	
15	18,1	21,3	35,9	40	27	
20	23,7	26,9	42,9	41	27	
25	29,7	33,7	48,9	47	32	
32	38,4	42,4	54,9	47	32	
40	44,3	48,3	66,9	48	31	
50	56,3	60,3	84,9	62	40	
65	72,1	76,1	98,9	61	40	
80	84,3	88,9	118,9	68	40	

NW	D1	D2	L	L1	E	
						Nut DIN11851
						<i>Wartelmoer DIN 11851</i>
8	38	19	18	15	Rd 28 x 1/8"	
10	44	25	18	15	Rd 34 x 1/8"	
15	54	31	20	17	Rd 44 x 1/6"	
20	63	36	21	18	Rd 52 x 1/6"	
25	70	42	21	18	Rd 58 x 1/6"	
32	78	49	21	18	Rd 65 x 1/6"	
40	92	62	22	19	Rd 78 x 1/6"	
50	112	80	25	21	Rd 95 x 1/6"	
65	127	94	29	25	Rd 110 x 1/4"	
80	148	115	31	26	Rd 130 x 1/4"	

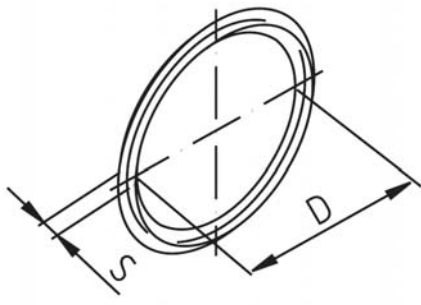
<i>O-ring DIN 11864/1 11866 E</i>	NW	D	S
<i>O-ring DIN 11864/1 11866 B</i>			
	8	12	3,5
	10	16	3,5
	15	20	3,5
	20	26	3,5
	25	32	5
	32	40,5	5
	40	46,5	5
	50	58,5	5
	65	73,5	5
	80	86,5	5

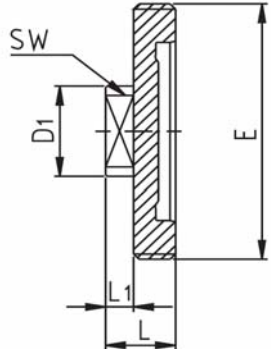
<i>Male blank DIN 11864/1 11866 E</i>	NW	D1	SW	L	L1	E
<i>Blinddraadstuk DIN 11864/1 11866 B</i>						
	8	25	22	22	10	Rd 28 x 1/8"
	10	25	22	22	10	Rd 34 x 1/8"
	15	25	22	24	10	Rd 44 x 1/6"
	20	34	27	24	10	Rd 52 x 1/6"
	25	34	27	24	10	Rd 58 x 1/6"
	32	34	27	24	10	Rd 65 x 1/6"
	40	34	27	24	10	Rd 78 x 1/6"
	50	34	27	26	10	Rd 95 x 1/6"
	65	34	27	30	10	Rd 110 x 1/4"
	80	34	27	30	10	Rd 130 x 1/4"

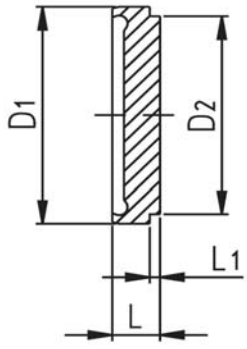
<i>Liner blank DIN 11864/1 11866 E</i>	NW	D1	D2	L	L1
<i>Blindpuntstuk DIN 11864/1 11866 B</i>					
	8	21,9	18	10	3
	10	27,9	24	10	3
	15	35,9	30	10	3
	20	42,9	35	12	3
	25	48,9	41	13	3
	32	54,9	48	13	3
	40	66,9	61	14	3
	50	84,9	79	16	4
	65	98,9	93	16	4
	80	118,9	114	20	5

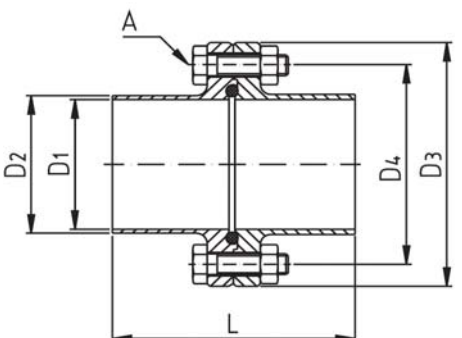
NW	D1	D2	D3	D4	L	A	Flange connection DIN 11864/2 11866 E Flensverbinding DIN 11864/2 11866 B
8	10,3	13,5	54	37	80	4/M8 x 30	
10	14,0	17,2	59	42	80	4/M8 x 30	
15	18,1	21,3	62	45	80	4/M8 x 30	
20	23,7	26,9	69	52	80	4/M8 x 30	
25	29,7	33,7	74	57	90	4/M8 x 30	
32	38,4	42,4	82	65	90	4/M8 x 30	
40	44,3	48,3	88	71	90	4/M8 x 30	
50	56,3	60,3	103	85	108	4/M8 x 30	
65	72,1	76,1	125	104	112	8/M10 x 30	
80	84,3	88,9	137	116	116	8/M10 x 35	

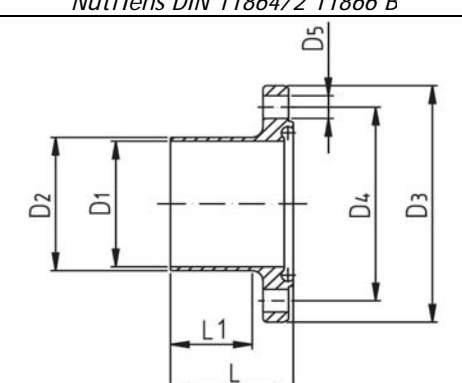
NW	D1	D2	D3	D4	L	L1	Nut flange DIN 11864/2 11866 c Nutflens DIN 11864/2 11866 B
8	10,3	13,5	54	37	41,5	26	
10	14,0	17,2	59	42	41,5	26	
15	18,1	21,3	62	45	41,5	26	
20	23,7	26,9	69	52	41,5	26	
25	29,7	33,7	74	57	46,5	31	
32	38,4	42,4	82	65	46,5	31	
40	44,3	48,3	88	71	46,5	31	
50	56,3	60,3	103	85	55,5	40	
65	72,1	76,1	125	104	57,5	40	
80	84,3	88,9	137	116	59,5	42	

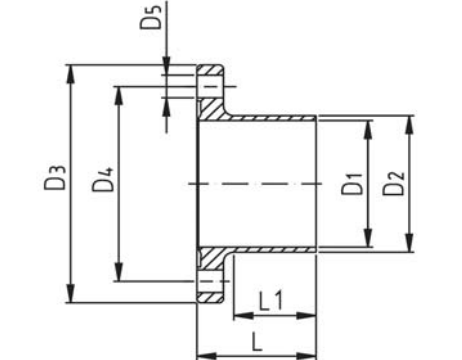
NW	D1	D2	D3	D4	L	L1	Clamp liner DIN 11864/2 11866 E Bundferrule DIN 11864/2 11866 B
8	10,3	13,5	54	37	40	26	
10	14,0	17,2	59	42	40	26	
15	18,1	21,3	62	45	40	26	
20	23,7	26,9	69	52	40	26	
25	29,7	33,7	74	57	45	31	
32	38,4	42,4	82	65	45	31	
40	44,3	48,3	88	71	45	31	
50	56,3	60,3	103	85	54	40	
65	72,1	76,1	125	104	56	40	
80	84,3	88,9	137	116	58	42	

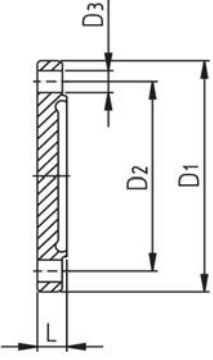
<i>Blank nut flange DIN 11864/2 11866 E</i> <i>Blindnutflens DIN 11864/2 11866 B</i>	NW	D1	D2	D3	L
	8	54	37	4x ø 9	11,5
	10	59	42	4x ø 9	11,5
	15	62	45	4x ø 9	11,5
	20	69	52	4x ø 9	11,5
	25	74	57	4x ø 9	11,5
	32	82	65	4x ø 9	11,5
	40	88	71	4x ø 9	11,5
	50	103	85	4x ø 9	11,5
	65	125	104	8x ø 11	13,5
	80	137	116	8x ø 11	13,5

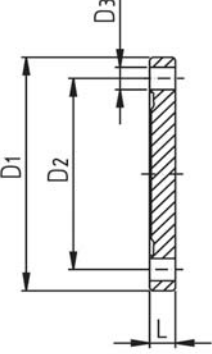
<i>Blank liner flange DIN 11864/2 11866 E</i> <i>Blindbundflens DIN 11864/2 11866 B</i>	NW	D1	D2	D3	L
	8	54	37	4x ø 9	10
	10	59	42	4x ø 9	10
	15	62	45	4x ø 9	10
	20	69	52	4x ø 9	10
	25	74	57	4x ø 9	10
	32	82	65	4x ø 9	10
	40	88	71	4x ø 9	10
	50	103	85	4x ø 9	10
	65	125	104	8x ø 11	12
	80	137	116	8x ø 11	12

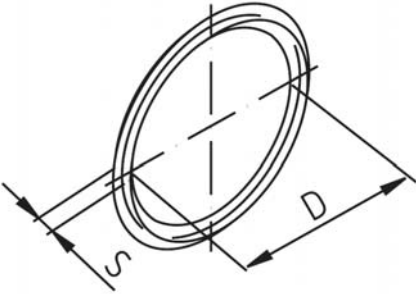
<i>O-ring DIN 11864/1 11866 E</i> <i>O-ring DIN 11864/1 11866 B</i>	NW	D	S
	8	12	3,5
	10	16	3,5
	15	20	3,5
	20	26	3,5
	25	32	5
	32	40,5	5
	40	46,5	5
	50	58,5	5
	65	73,5	5
80	86,5	5	

NW	D1	D2	D3	A	L
8	10,3	13,5	34	45	76
10	14,0	17,2	34	45	76
15	18,1	21,3	34	45	78
20	23,7	26,9	50,5	64	78
25	29,7	33,7	50,5	64	88
32	38,4	42,4	64	77	88
40	44,3	48,3	64	77	90
50	56,3	60,3	91	104	114
65	72,1	76,1	106	119	117
80	84,3	88,9	119	132	122

Clamp connection DIN 11864/3 11866 E
Klemverbinding DIN 11864/3 11866 B

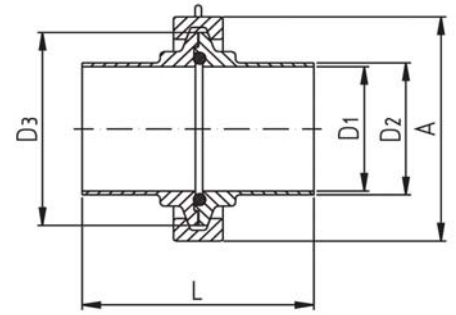

NW	D1	D2	D3	L	L1
8	10,3	13,5	34	38	26
10	14,0	17,2	34	38	26
15	18,1	21,3	34	38	26
20	23,7	26,9	50,5	38	26
25	29,7	33,7	50,5	38,5	28
32	38,4	42,4	64	44	30
40	44,3	48,3	64	44	30
50	56,3	60,3	91	44,5	30
65	72,1	76,1	106	56,5	40
80	84,3	88,9	119	58,5	40

Clamp liner DIN 11864/3 11866 B
Bundferrule DIN 11864/3 11866 E

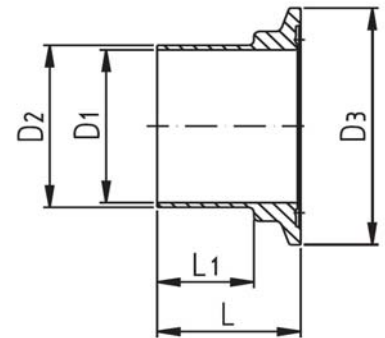

NW	D1	D2	D3	L	L1
8	10,3	13,5	34	39,5	26
10	14,0	17,2	34	39,5	26
15	18,1	21,3	34	40,5	26
20	23,7	26,9	50,5	40	26
25	29,7	33,7	50,5	45,5	28
32	38,4	42,4	64	45,5	30
40	44,3	48,3	64	46,5	30
50	56,3	60,3	91	58,5	30
65	72,1	76,1	106	60	40
80	84,3	88,9	119	62,5	40

Clamp Nut DIN 11864/3 11866 E
Nutferrule DIN 11864/3 11866 B

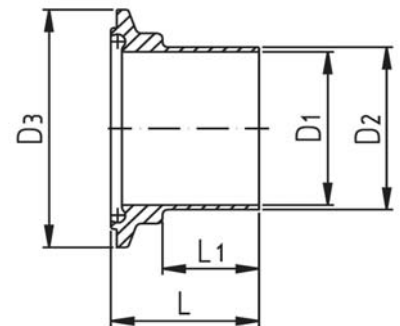

NW	A	B	D1
8	45	63	34
10	45	63	34
15	45	63	34
20	64	88	50,5
25	64	88	50,5
32	77	105	64
40	77	105	64
50	104	137	91
65	119	155	106
80	132	168	119

Heavy duty clamp
Clampbeugel 2 delig zwaar

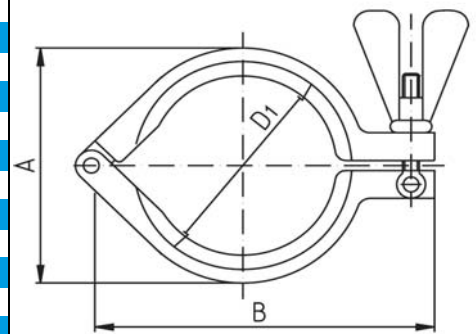

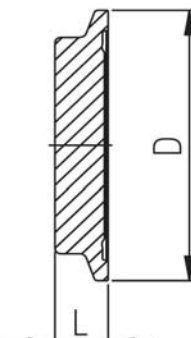
<i>Blind cap DIN 11864/3 11866 E</i> <i>Blindbundferule DIN 11864/3 11866 B</i>	NW	D	L
	8	34	8
	10	34	8
	15	34	8
	20	50,5	8
	25	50,5	8
	32	64	8
	40	64	8
	50	91	8
	65	106	8
	80	119	8

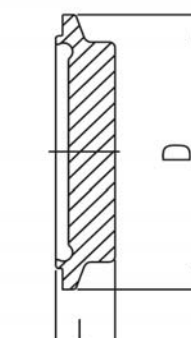
<i>Blind clamp DIN 11864/3 11866 E</i> <i>Blindnutferrule DIN 11864/3 11866 B</i>	NW	D	L
	8	34	10
	10	34	10
	15	34	10
	20	50,5	10
	25	50,5	10
	32	64	10
	40	64	10
	50	91	10
	65	106	10
	80	119	10

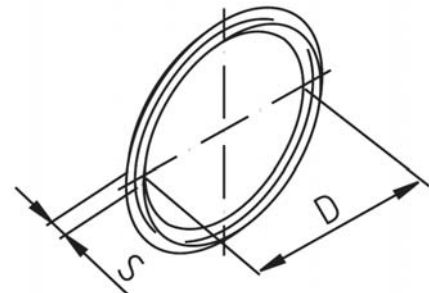
<i>O-ring DIN 11864/1 11866 E</i> <i>O-ring DIN 11864/1 11866 B</i>	NW	D	S
	8	12	3,5
	10	16	3,5
	15	20	3,5
	20	26	3,5
	25	32	5
	32	40,5	5
	40	46,5	5
	50	58,5	5
	65	73,5	5
	80	86,5	5

NW	D1	D2	D3	L	E	<i>Union DIN 11853/1 11850 (2)</i> <i>Koppeling DIN 11853/1 11850 (2)</i>
10	10	13	38	32	Rd 28 x 1/8"	
15	16	19	44	32	Rd 34 x 1/8"	
20	20	23	54	34	Rd 44 x 1/6"	
25	26	29	63	42	Rd 52 x 1/6"	
32	32	35	70	48	Rd 58 x 1/6"	
40	38	41	78	50	Rd 65 x 1/6"	
50	50	53	92	54	Rd 78 x 1/6"	
65	66	70	112	62	Rd 95 x 1/6"	
80	81	85	127	72	Rd 110 x 1/4"	
100	100	104	148	86	Rd 130 x 1/4"	

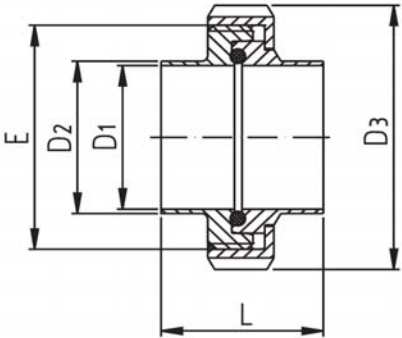

NW	D1	D2	L	L1	E	<i>Male DIN 11853/1 11850 (2)</i> <i>Draadstuk DIN 11853/1 11850 (2)</i>
10	10	13	19	5	Rd 28 x 1/8"	
15	16	19	19	5	Rd 34 x 1/8"	
20	20	23	21	5	Rd 44 x 1/6"	
25	26	29	26	10	Rd 52 x 1/6"	
32	32	35	30	14	Rd 58 x 1/6"	
40	38	41	31	15	Rd 65 x 1/6"	
50	50	53	31	15	Rd 78 x 1/6"	
65	66	70	36	16	Rd 95 x 1/6"	
80	81	85	42	18	Rd 110 x 1/4"	
100	100	104	50	26	Rd 130 x 1/4"	

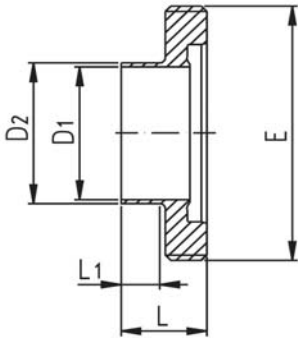

NW	D1	D2	D3	L	L1	<i>Liner DIN 11853/1 11850 (2)</i> <i>Puntstuk DIN 11853/1 11850 (2)</i>
10	10	13	21,9	17	5	
15	16	19	27,9	17	5	
20	20	23	35,9	18	5	
25	26	29	42,9	22	8	
32	32	35	48,9	25	10	
40	38	41	54,9	26	10	
50	50	53	66,9	30	13	
65	66	70	84,9	34	15	
80	81	85	98,9	38	15	
100	100	104	118,9	46	23	

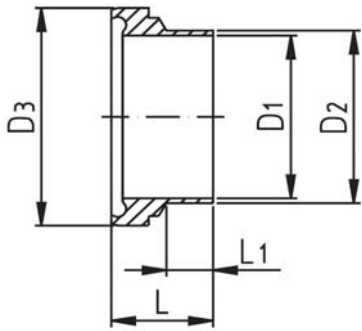

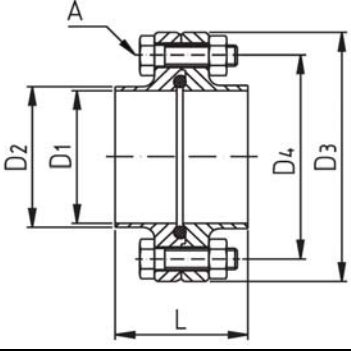
<i>Flange connection DIN 11853/2 11850 (2), Flenverbinding DIN 11853/2 11850 (2)</i>	NW	D1	D2	D3	D4	L	A
	10	10	13	54	37	48	4/M8 x 30
	15	16	19	59	42	48	4/M8 x 30
	20	20	23	64	47	48	4/M8 x 30
	25	26	29	70	53	48	4/M8 x 30
	32	32	35	76	59	48	4/M8 x 30
	40	38	41	82	65	48	4/M8 x 30
	50	50	53	94	77	48	4/M8 x 30
	65	66	70	113	95	48	8/M8 x 30
	80	81	85	133	112	52	8/M10 x 35
	100	100	104	159	137	52	8/M10 x 40
	125	125	129	183	161	56	8/M10 x 40
	150	150	154	213	188	56	8/M12 x 50

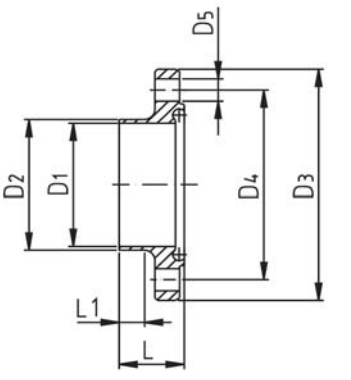
<i>Nut flange DIN 11853/2 11850 (2), Nutflens DIN 11853/2 11850 (2)</i>	NW	D1	D2	D3	D4	L	L1
	10	10	13	54	37	25,5	10
	15	16	19	59	42	25,5	10
	20	20	23	64	47	25,5	10
	25	26	29	70	53	25,5	10
	32	32	35	76	59	25,5	10
	40	38	41	82	65	25,5	10
	50	50	53	94	77	25,5	10
	65	66	70	113	95	25,5	10
	80	81	85	133	112	27,5	10
	100	100	104	159	137	27,5	10
	125	125	129	183	161	29,5	10
	150	150	154	213	188	29,5	8

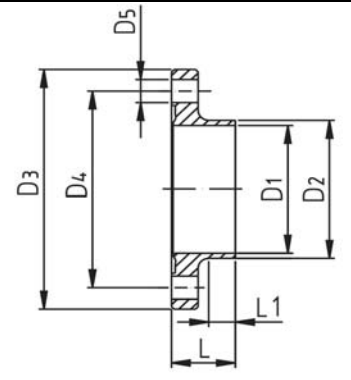
<i>Liner flange DIN 11853/2 11850 (2), Bundflens DIN 11853/2 11850 (2)</i>	NW	D1	D2	D3	D4	L	L1
	10	10	13	54	37	24	10
	15	16	19	59	42	24	10
	20	20	23	64	47	24	10
	25	26	29	70	53	24	10
	32	32	35	76	59	24	10
	40	38	41	82	65	24	10
	50	50	53	94	77	24	10
	65	66	70	113	95	24	10
	80	81	85	133	112	36	10
	100	100	104	159	137	26	10
	125	125	129	183	161	28	10
	150	150	154	213	188	28	8

NW	D1	D2	D3	A	L
10	10	13	34	45	34
15	16	19	34	45	45
20	20	23	50,5	64	64
25	26	29	50,5	64	64
32	32	35	50,5	64	64
40	38	41	64	77	77
50	50	53	77,5	91	91
65	66	70	91	104	104
80	81	85	106	119	119
100	100	104	130	143	132

Clamp connection DIN 11853/3 11850 (2)
Klemverbindung DIN 11853/3 11850 (2)

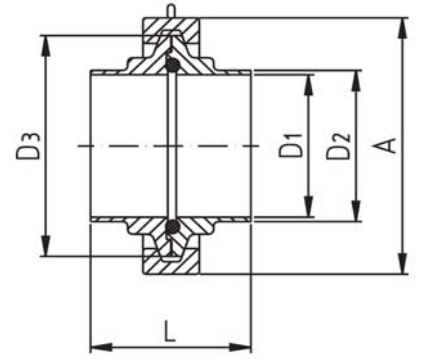

NW	D1	D2	D3	L	L1
10	10	13	34	17	5
15	16	19	34	17	5
20	20	23	50,5	17	5
25	26	29	50,5	18,5	8
32	32	35	50,5	24	10
40	38	41	64	24	10
50	50	53	77,5	27,5	13
65	66	70	91	31,5	15
80	81	85	106	33,5	15
100	100	104	130	43	23

Clamp liner DIN 11853/3 11850 (2)
Bundferrule DIN 11853/3 11850 (2)

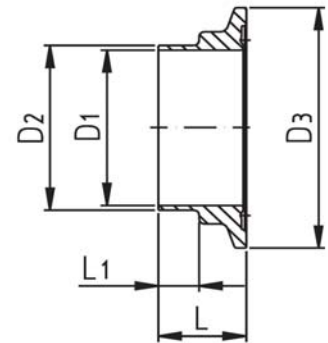

NW	D1	D2	D3	L	L1
10	10	13	34	18,5	5
15	16	19	34	18,5	5
20	20	23	50,5	18,5	5
25	26	29	50,5	20	8
32	32	35	50,5	25,5	10
40	38	41	64	25,5	10
50	50	53	77,5	29	13
65	66	70	91	33	15
80	81	85	106	35	15
100	100	104	130	44,5	23

Clamp Nut DIN 11853/3 11850 (2)
Nutferrule DIN 11853/3 11850 (2)

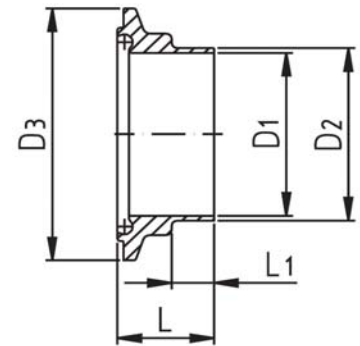

<i>Union DIN 11853/1 ISO 2037</i>		NW	D1	D2	D3	L	E
<i>Koppeling DIN 11853/1 ISO 2037</i>							
	1/2"	9,4	12,7	38	40		Rd 28 x 1/8"
	3/4"	15,75	19,05	44	40		Rd 34 x 1/8"
	1"	22,1	25,4	63	42		Rd 52 x 1/6"
	1,5"	34,8	38,1	78	50		Rd 65 x 1/6"
	2"	47,5	50,8	92	54		Rd 78 x 1/6"
	2,5"	60,2	63,5	112	62		Rd 95 x 1/6"
	3"	72,9	76,2	127	72		Rd 110 x 1/4"
	4"	97,38	101,6	148	86		Rd 130 x 1/4"

<i>Male DIN 11853/1 ISO 2037</i>		NW	D1	D2	L	L1	E
<i>Draadstuk DIN 11853/1 ISO 2037</i>							
	1/2"	9,4	12,7	23	9		Rd 28 x 1/8"
	3/4"	15,75	19,05	23	9		Rd 34 x 1/8"
	1"	22,1	25,4	26	10		Rd 52 x 1/6"
	1,5"	34,8	38,1	31	15		Rd 65 x 1/6"
	2"	47,5	50,8	31	15		Rd 78 x 1/6"
	2,5"	60,2	63,5	36	18		Rd 95 x 1/6"
	3"	72,9	76,2	42	18		Rd 110 x 1/4"
	4"	97,38	101,6	50	26		Rd 130 x 1/4"

<i>Liner DIN 11853/1 ISO 2037</i>		NW	D1	D2	D3	L	L1
<i>Puntstuk DIN 11853/1 ISO 2037</i>							
	1/2"	9,4	12,7	21,9	21	9	
	3/4"	15,75	19,05	27,9	21	9	
	1"	22,1	25,4	42,9	22	8	
	1,5"	34,8	38,1	54,9	26	9,5	
	2"	47,5	50,8	66,9	30	12,5	
	2,5"	60,2	63,5	84,9	34	21	
	3"	72,9	76,2	98,9	38	17	
	4"	97,38	101,6	118,9	46	21	

NW	D1	D2	D3	D4	L	A
1/2"	9,4	12,7	54	37	48	4/M8 x 30
3/4"	15,75	19,05	59	42	48	4/M8 x 30
1"	22,1	25,4	66	49	48	4/M8 x 30
1,5"	34,8	38,1	79	62	48	4/M8 x 30
2"	47,5	50,8	92	75	48	4/M8 x 30
2,5"	60,2	63,5	107	89	48	8/M8 x 30
3"	72,9	76,2	125	104	48	8/M10 x 30
4"	97,38	101,6	157	135	52	8/M10 x 35

Flange connection DIN 11853/2 ISO 2037
Flenverbinding DIN 11853/2 ISO 2037

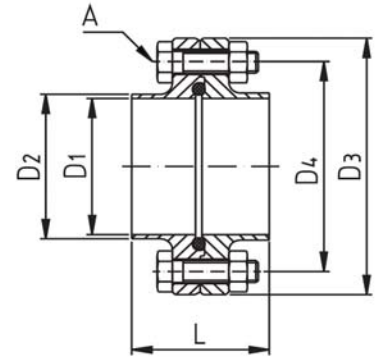

NW	D1	D2	D3	D4	L	L1
1/2"	9,4	12,7	54	37	25,5	10
3/4"	15,75	19,05	59	42	25,5	10
1"	22,1	25,4	66	49	25,5	10
1,5"	34,8	38,1	79	62	25,5	10
2"	47,5	50,8	92	75	25,5	10
2,5"	60,2	63,5	107	89	25,5	10
3"	72,9	76,2	125	104	25,5	8
4"	97,38	101,6	157	135	27,5	8

Nut flange DIN 11853/2 ISO 2037
Nutflens DIN 11853/2 ISO 2037

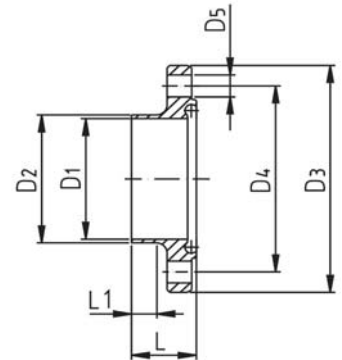

NW	D1	D2	D3	D4	L	L1
1/2"	9,4	12,7	54	37	24	10
3/4"	15,75	19,05	59	42	24	10
1"	22,1	25,4	66	49	24	10
1,5"	34,8	38,1	79	62	24	10
2"	47,5	50,8	92	75	24	10
2,5"	60,2	63,5	107	89	24	10
3"	72,9	76,2	125	104	24	8
4"	97,38	101,6	157	135	26	8

Liner flange DIN 11853/2 ISO 2037
Bundflens DIN 11853/2 ISO 2037

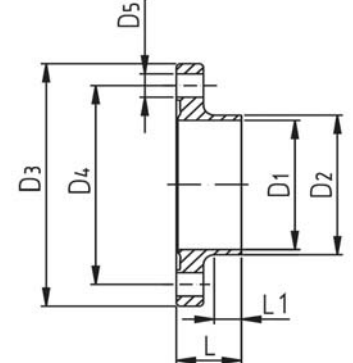

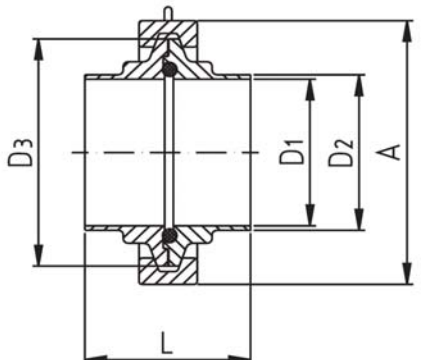
<i>Clamp connection DIN 11853/3 ISO 2037</i> <i>Klemverbinding DIN 11853/3 ISO 2037</i>	NW	D1	D2	D3	A	L
	1/2"	9,4	12,7	34	45	34
	3/4"	15,75	19,05	34	45	34
	1"	22,1	25,4	50,5	64	35
	1,5"	34,8	38,1	64	77	48
	2"	47,5	50,8	77,5	91	55
	2,5"	60,2	63,5	91	104	61
	3"	72,9	76,2	106	119	71
	4"	97,38	101,6	130	143	83

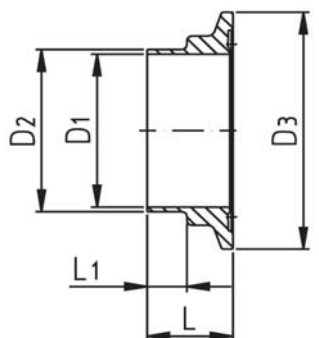
<i>Clamp liner DIN 11853/3 ISO 2037</i> <i>Bundferrule DIN 11853/3 ISO 2037</i>	NW	D1	D2	D3	L	L1
	1/2"	9,4	12,7	34	17	5
	3/4"	15,75	19,05	34	17	5
	1"	22,1	25,4	50,5	17,5	7
	1,5"	34,8	38,1	64	24	10
	2"	47,5	50,8	77,5	27,5	13
	2,5"	60,2	63,5	91	30,5	13
	3"	72,9	76,2	106	35,5	17
	4"	97,38	101,6	130	41,5	22

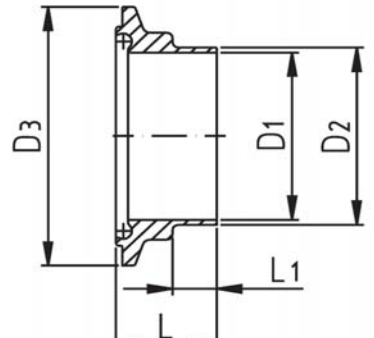
<i>Clamp Nut DIN 11853/3 ISO 2037</i> <i>Nutferrule DIN 11853/3 ISO 2037</i>	NW	D1	D2	D3	L	L1
	1/2"	9,4	12,7	34	18,5	5
	3/4"	15,75	19,05	34	18,5	5
	1"	22,1	25,4	50,5	19	7
	1,5"	34,8	38,1	64	25,5	10
	2"	47,5	50,8	77,5	29	13
	2,5"	60,2	63,5	91	32	13
	3"	72,9	76,2	106	37	17
	4"	97,38	101,6	130	43	22

NW	D1	D2	D3	L	E
<i>Union DIN 11853/1 11866 (B), Koppeling DIN 11853/1 11866 (B)</i>					
8	10,3	13,5	38	32	Rd 28 x 1/8"
10	14,0	17,2	44	32	Rd 34 x 1/8"
15	18,1	21,3	54	34	Rd 44 x 1/6"
20	23,7	26,9	63	42	Rd 52 x 1/6"
25	29,7	33,7	70	48	Rd 58 x 1/6"
32	38,4	42,4	78	50	Rd 65 x 1/6"
40	44,3	48,3	92	50	Rd 78 x 1/6"
50	56,3	60,3	112	54	Rd 95 x 1/6"
65	72,1	76,1	127	72	Rd 110 x 1/4"
80	84,3	88,9	148	86	Rd 130 x 1/4"

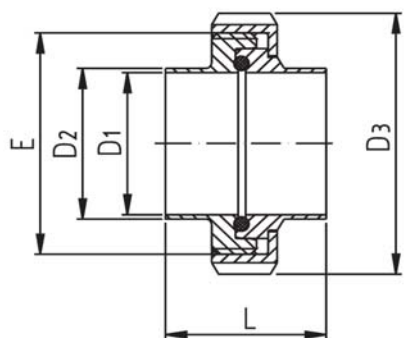

NW	D1	D2	L	L1	E
<i>Male DIN 11853/1 11866 (B), Draadstuk DIN 11853/1 11866 (B)</i>					
8	10,3	13,5	19	5	
10	14,0	17,2	19	5	
15	18,1	21,3	21	5	
20	23,7	26,9	26	7	
25	29,7	33,7	30	9	
32	38,4	42,4	31	11	
40	44,3	48,3	31	12	
50	56,3	60,3	36	12	
65	72,1	76,1	42	17	
80	84,3	88,9	50	18	

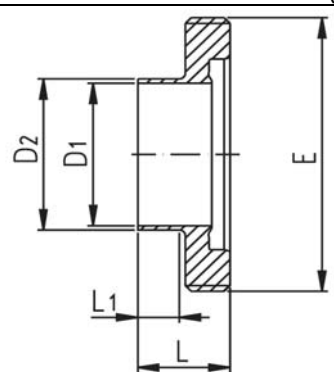

NW	D1	D2	D3	L	L1
<i>Liner DIN 11853/1 11866 (B), Puntstuk DIN 11853/1 11866 (B)</i>					
8	10,3	13,5	21,9	17	5
10	14,0	17,2	27,9	17	5
15	18,1	21,3	35,9	18	5
20	23,7	26,9	42,9	22	7
25	29,7	33,7	48,9	25	9
32	38,4	42,4	54,9	25	11
40	44,3	48,3	66,9	30	12
50	56,3	60,3	84,9	34	12
65	72,1	76,1	98,9	38	17
80	84,3	88,9	118,9	46	18

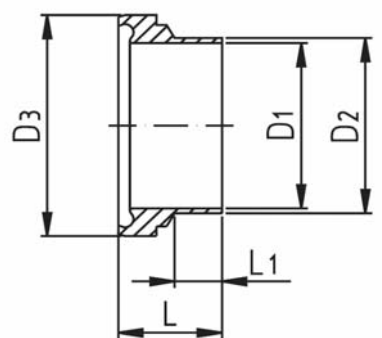

<i>Flange connection DIN 11853/2 11866 (B)</i> <i>Flenverbinding DIN 11853/2 11866 (B)</i>	NW	D1	D2	D3	D4	L	A
	8	10,3	13,5	54	37	48	4/M8 x 30
	10	14,0	17,2	59	42	48	4/M8 x 30
	15	18,1	21,3	62	45	48	4/M8 x 30
	20	23,7	26,9	69	52	48	4/M8 x 30
	25	29,7	33,7	74	57	48	4/M8 x 30
	32	38,4	42,4	82	65	48	4/M8 x 30
	40	44,3	48,3	88	71	48	4/M8 x 30
	50	56,3	60,3	103	85	48	4/M8 x 30
	65	72,1	76,1	125	104	52	8/M10 x 30
	80	84,3	88,9	137	116	52	8/M10 x 35

<i>Nut flange DIN 11853/2 11866 (B)</i> <i>Nutflens DIN 11853/2 11866 (B)</i>	NW	D1	D2	D3	D4	L	L1
	8	10,3	13,5	54	37	25,5	10
	10	14,0	17,2	59	42	25,5	10
	15	18,1	21,3	62	45	25,5	10
	20	23,7	26,9	69	52	25,5	10
	25	29,7	33,7	74	57	25,5	10
	32	38,4	42,4	82	65	25,5	10
	40	44,3	48,3	88	71	25,5	10
	50	56,3	60,3	103	85	25,5	8
	65	72,1	76,1	125	104	27,5	10
	80	84,3	88,9	137	116	27,5	8

<i>Clamp liner DIN 11853/2 11866 (B)</i> <i>Bundferrule DIN 11853/2 11866 (B)</i>	NW	D1	D2	D3	D4	L	L1
	8	10,3	13,5	54	37	24	10
	10	14,0	17,2	59	42	24	10
	15	18,1	21,3	62	45	24	10
	20	23,7	26,9	69	52	24	10
	25	29,7	33,7	74	57	24	10
	32	38,4	42,4	82	65	24	10
	40	44,3	48,3	88	71	24	10
	50	56,3	60,3	103	85	24	8
	65	72,1	76,1	125	104	26	10
	80	84,3	88,9	137	116	26	8

NW	D1	D2	D3	A	L
8	10,3	13,5	34	45	34
10	14,0	17,2	34	45	34
15	18,1	21,3	34	45	36
20	23,7	26,9	50,5	64	31,5
25	29,7	33,7	50,5	64	46
32	38,4	42,4	64	77	50
40	44,3	48,3	64	77	54
50	56,3	60,3	91	104	58
65	72,1	76,1	106	119	71
80	84,3	88,9	119	132	78

Clamp connection DIN 11853/3 11866 (B)
Klemverbinding DIN 11853/3 11866 (B)

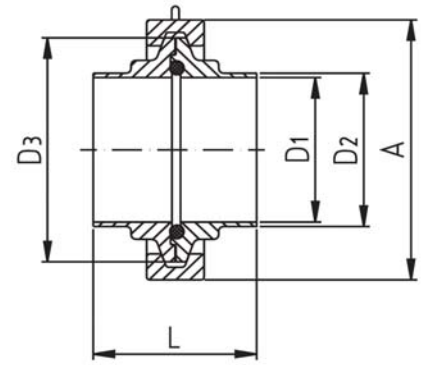

NW	D1	D2	D3	L	L1
8	10,3	13,5	34	17	5
10	14,0	17,2	34	17	5
15	18,1	21,3	34	18	5
20	23,7	26,9	50,5	16	7
25	29,7	33,7	50,5	23	9
32	38,4	42,4	64	25	11
40	44,3	48,3	64	27	12
50	56,3	60,3	91	29	12
65	72,1	76,1	106	35,5	17
80	84,3	88,9	119	39	18

Clamp liner DIN 11853/3 11866 (B)
Bundferrule DIN 11853/3 11866 (B)

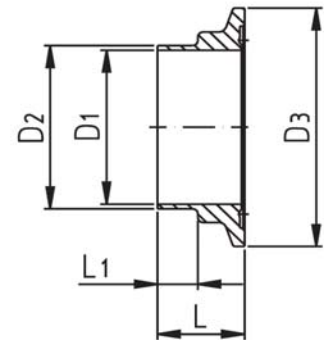

NW	D1	D2	D3	L	L1
8	10,3	13,5	34	18,5	5
10	14,0	17,2	34	18,5	5
15	18,1	21,3	34	19,5	5
20	23,7	26,9	50,5	17	7
25	29,7	33,7	50,5	24,5	9
32	38,4	42,4	64	26,5	11
40	44,3	48,3	64	28,5	12
50	56,3	60,3	91	30,5	12
65	72,1	76,1	106	37	17
80	84,3	88,9	119	40,5	18

Clamp Nut DIN 11853/3 11866 (B)
Nutferrule DIN 11853/3 11866 (B)

